

LIFE COMES IN
MANY FLAVORS



OptiVend Next Generation
Tastes differ.

ANIMO



A NEW GENERATION

Animo's new OptiVend Next Generation is an instant machine for fresh, hot coffee any moment of the day. Just choose your favorite and a steaming cup is ready in seconds at the touch of a button.

Espresso? Cappuccino? Or maybe tea?
With Optivend, the choice is yours.
Because tastes differ.



OptiVend. *Tastes differ.*

FULL OF TASTE

How do you start the day: a long cappuccino or a short, strong espresso? Tastes differ when it comes to coffee. And variety makes life richer.

With OptiVend, you can choose exactly what you feel like, any moment of the day.

- + The drink menu has 7 to 12 easily programmed drink buttons, so the choice is always yours.
- + OptiVend accommodates from 1 to 6 instant ingredient canisters. More canisters mean more choice.
- + Strength is easily adjustable to suit personal preferences, because tastes differ.
- + OptiVend has a separate tap for hot water, so tea always tastes like it should.
- + See your choice clearly displayed.



+ Clear option buttons



+ 1 to 6 canisters



+ Clear display and adjustable coffee strength



QUICK AND EASY

OptiVend is user-friendly in every sense. It's easy to install, operate and maintain. Our technology and construction ensure years of hassle-free use. OptiVend is always ready to go.

- + Buttons are simple to operate and your choice is clearly displayed.
- + OptiVend is high in capacity, making cup after cup with no waiting time.
- + With an OptiVend running on three-phase power (optional), you can make jug after jug without any waiting time.
- + OptiVend can be installed anywhere. An electrical outlet and water supply are all you need. If there is no water supply nearby, a stand-alone set is available (see accessories).
- + Refilling is easy, with no mess.
- + OptiVend is cleaned without opening up the machine. Easy and hygienic.
- + OptiVend comes pre-programmed, so setup is as easy as plug and play.
- + Drink options are easily set and changed. A pin code is required to avoid unintended reprogramming.





ALWAYS READY

A quick cup or a whole thermos jug for the meeting room? OptiVend Next Generation is always ready, and quick to produce large quantities. So you'll never have to wait long.

Your coffee has the right taste and temperature every time. Reliable technology and durable construction mean OptiVend will run smoothly for years to come.

- + OptiVend's timer is adjustable for up to three different periods of the day.
- + Energy Saving Mode minimizes power consumption when on standby.
- + The stainless-steel shell is indestructible and fully recyclable.
- + The boiler is well insulated for energy efficiency.

More efficient

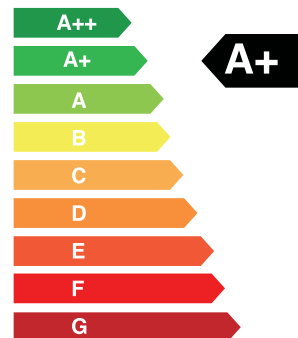

Less efficient

Norm EVA - Energy Measurement Protocol (version 3.0B - 14/2/2011)



DESIGN

FOR EVERY ENVIRONMENT

OptiVend Next Generation is powerful inside and beautiful outside. It's compact and flexible with its own unique look.

Large buttons and LCD display are user-friendly and inviting.

OptiVend's sleek design is at home in any setting: cafeterias, sports clubs, hotels, theaters, event venues, hospitals, schools and, of course, offices.

- + The design is a combination of stainless steel with a front color panel. It comes in red, white, black and grey.
- + OptiVend's compact size means it doesn't take a lot of space. And it's at home in any interior style.
- + OptiVend comes in different models and versions: for cups only, for thermos jugs, and with more or fewer drink options.
- + The display and menu buttons are inviting and userfriendly.





MODELS AND MENUS

- + Up to 6 canisters for powdered ingredients
- + Separate taps for coffee and hot water
- + Models for cups and thermos jugs
- + Adjustable coffee strength
- + STOP button
- + Intelligent Energy Saving Mode
- + Cleaning program (on the control panel)
- + Usage counter
- + Adjustable rpm of mixer motor
- + Insulated stainless steel with dry-boil protection
- + Adjustable temperature
- + Stainless steel housing
- + Telemetry compatible (EVA DTS)
- + Available in white (RAL 9003), black grey (RAL 7021) and red (RAL 3001)

LARGE CANISTERS

Large ingredient canisters last longer between refills.

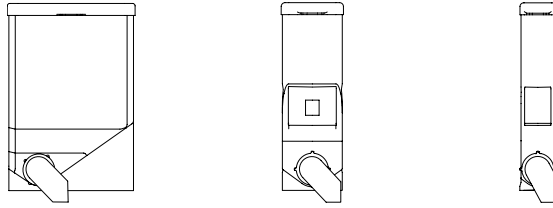

	5.1 LITER	2.3 LITER	1.2 LITER
Coffee	± 1300 g / 640 cups	± 500 g / 250 cups	± 300 g / 150 cups
Topping	± 3200 g / 265 cups*	± 1350 g / 115 cups*	± 750 g / 65 cups*
Cocoa	± 3600 g / 200 cups	± 1500 g / 85 cups	± 800 g / 45 cups
Sugar		± 1900 g / 450 cups	± 1060 g / 245 cups
Tea			± 940 g / 235 cups
Decaf			± 300 g / 150 cups

*Cappuccino

DRINK OPTIONS

Drink options depend on the ingredients that you select for each canister.

Adjustable controls make it easy to change the options.

DRINK OPTIONS	11s	11(s) TS & 11 TL	21s	22 TS	32s	32 (TS)	33 (TS)	42 (TS)	43 (TS)	53 (TS)	63 (TS)
Coffee (thermos jugs)	✓	✓	✓	✓	✓	✓	✓	✓	✓	✓	✓
Coffee with milk			✓	✓	✓	✓	✓	✓	✓	✓	✓
Espresso	✓	✓	✓	✓	✓	✓	✓	✓	✓	✓	✓
Cappuccino			✓	✓	✓	✓	✓	✓	✓	✓	✓
Latte macchiato				⊙	⊙	⊙	⊙	⊙	⊙	⊙	⊙
Coffee choc			⊙	⊙	✓	✓	✓	✓	✓	⊙	⊙
Chocolate milk			⊙	⊙	✓	✓	✓	✓	✓	✓	✓
Wiener melange					✓	✓	✓	✓	✓	✓	⊙
Hot water	✓	✓	✓	✓	✓	✓	✓	✓	✓	✓	✓
Espresso choc			⊙	⊙	⊙	⊙	⊙	⊙	⊙	✓	✓
Decaf	⊙	⊙	⊙	⊙	⊙	⊙	⊙	⊙	⊙	✓	✓
Tea	⊙	⊙	⊙	⊙	⊙	⊙	⊙	⊙	⊙	⊙	✓
Coffee with sugar								✓	✓	✓	✓
Double espresso	⊙	⊙	⊙	⊙	⊙	⊙	⊙	⊙	⊙	⊙	⊙
Hot chocolat	⊙	⊙	⊙	⊙	⊙	⊙	⊙	⊙	⊙	⊙	⊙
Soup	⊙	⊙	⊙	⊙	⊙	⊙	⊙	⊙	⊙	⊙	⊙
Hot melk	⊙	⊙	⊙	⊙	⊙	⊙	⊙	⊙	⊙	⊙	⊙
Cold water	⊙	⊙	⊙	⊙	⊙	⊙	⊙	⊙	⊙	⊙	⊙

✓ STANDARD FACTORY SETTINGS

⊙ ADJUSTABLE (DEPENDING ON CHOSEN INGREDIENTS)

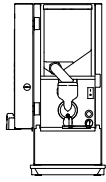

OV 11s NG

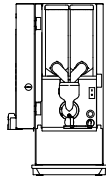

OV 21s NG

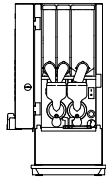

OV 32s NG

OPTIVEND s NG

(3 versions)

- + Suitable for cups
- + Canisters: max. 3
- + Drink buttons: 7
- + W 248 x D 501 x H 569 mm

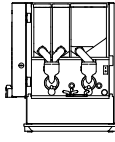

OV 32 NG

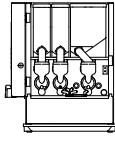

OV 33 NG

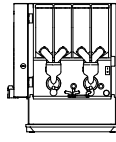

OV 42 NG

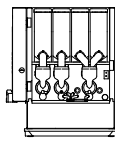

OV 43 NG

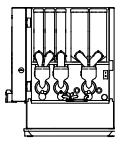

OV 53 NG

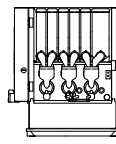

OV 63 NG

OPTIVEND NG

(6 versions)

- + Suitable for cups
- + Canisters: max. 6
- + Drink buttons: 12
- + W 409 x D 521 x H 569 mm

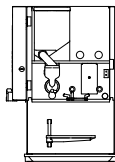

OV 11 TS NG

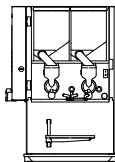

OV 22 TS NG

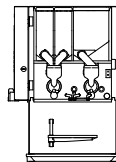

OV 32 TS NG

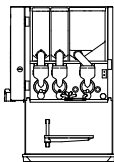

OV 33 TS NG

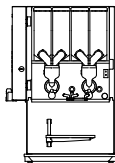

OV 42 TS NG

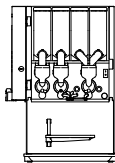

OV 43 TS NG

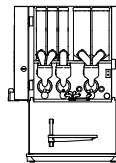

OV 53 TS NG

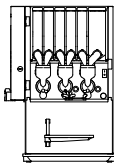

OV 63 TS NG

OPTIVEND TS NG

(8 versions)

- + Suitable for cups and thermos jugs
- + Canisters: max. 6
- + Drink buttons: 12
- + W 409 x D 521 x H 686 mm

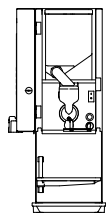

OV 11 (s) TS

OPTIVEND s TS NG

(1 version)

- + Suitable for cups and thermos jugs
- + Canisters: max. 1
- + Drink buttons: 7
- + W 248 x D 501 x H 686 mm

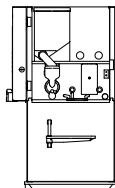

OV 11 TL NG

OPTIVEND TL NG

(1 version)

- + Suitable for cups, thermos jugs and pump pots
- + Canisters: 1
- + Drink buttons: 12
- + W 409 x D 521 x H 806 mm

OPTIONS AND ACCESSORIES

OPTIONS

- + Two-phase power (6,4 kW) increases capacity to 665 cups per hour
- + Cup detection
- + Thermos jug mode
- + Hot and cold water outlets (cooling unit in base cabinet)
- + Your company logo on the door and/or side panels



- + Various payment systems, including coin mechanisms (MDB).



- + Cup detection allows operation only when a cup or thermos jug is present.

ACCESSORIES

- + Base cabinet (worktop optional)
- + Stand-alone set (pump with water tank)
- + Water filter for reduced maintenance
- + Thermos jugs in five different sizes (1.5, 1.85, 2.0 and 2.1 liters)
- + Cup dispenser
- + Full package of cleaning products



- + Base cabinet
Useful for storing ingredient refills, sugar, milk and stirrers. The rear panel is recessed to make room for connections and, possibly, a filter.



- + Water filter
Filtering reduces the risk of limescale to keep your machine running smoothly and your coffee top quality.



- + Thermos jugs
Animo offers a wide assortment of insulated, stainless-steel jugs for hot drinks.



- + Cup dispenser
Stainless-steel cup dispenser, suitable for different sizes of coffee cups. Suitable for wall mounting.



- + Stand-alone set
No mains water supply?
Use the Flojet water pump. The complete set consists of a pump, water tank and six-meter connecting hose, which can be easily installed in a base cabinet.

TECHNICAL SPECIFICATIONS

- + Brewing time, cup (120 ml): 5 - 12 seconds
Brewing time, thermos jug (1.5 l): ca. 60 seconds
- + Hourly capacity: 360 cups (120 ml) / 40 liters hot water
- + Rated power: 230V / 50-60Hz / 3275W
- + Adjustable cup tray: 100 - 155 mm
- + Max. tap height: 118 mm / TS 235 mm / TL 355 mm
- + Boiler capacity: 2.7 l (OVs) / 5.5 l, stainless steel element, dry-boil protection
- + Compatible with various payment systems (MDB)
- + Water connection: 3/4"

OPTIVEND NG

All dimensions in millimeters.

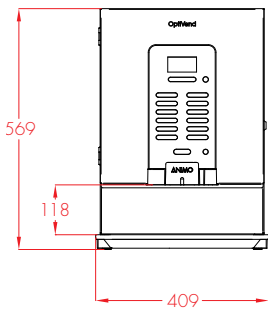

OPTIVEND TS / TL NG

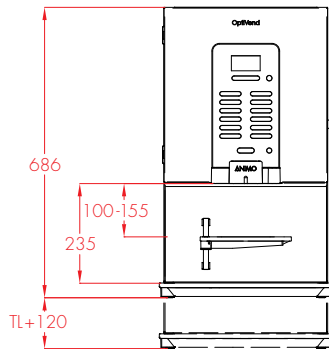

SIDE VIEW

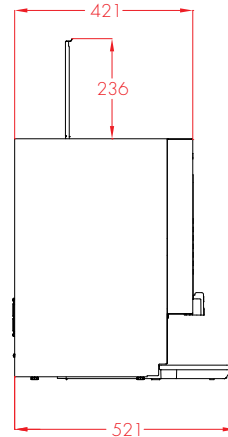

TOP VIEW

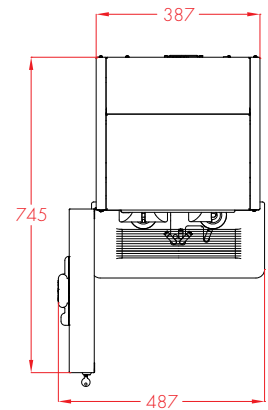

OPTIVEND s NG

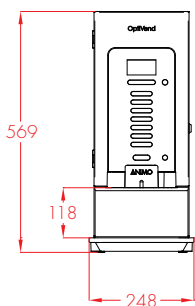

OPTIVEND s TS NG

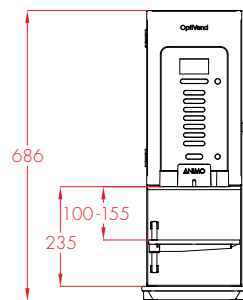

SIDE VIEW

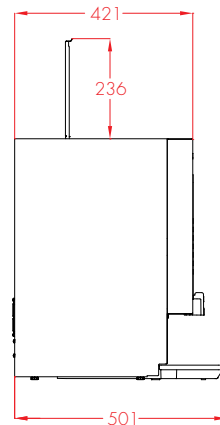

TOP VIEW

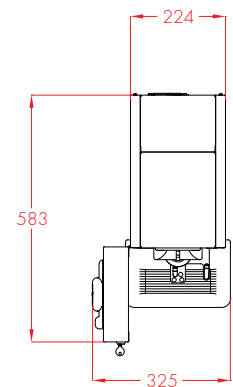



ANIMO

We make premium-quality coffee machines and equipment that are user-friendly, durable and convenient to maintain.

Our machines deliver a wide range of fresh, hot beverages time after time. Everything from freshly ground espresso, cappuccino or latte macchiato to tea, hot chocolate and instant soup.

We've been doing business for over 60 years in more than 75 countries worldwide.

Because good coffee takes a good machine. And a good machine takes experience, expertise and dedication.



DEDICATED TO EVERY CUP

WWW.ANIMO.EU/OPTIVEND

Animo B.V.
Head Office
Assen - The Netherlands

Sales Netherlands
Export Department
info@animo.nl
+31 (0)592 376 376

Animo B.V.B.A.
Belgium
info@animo.be
+32 (0)33 130 308

Animo France
France
info@animo-france.fr
+33 (0)380 250 660

Animo GmbH
Germany
info@animo-gmbh.de
+49 (0)541 971 250

1004008 12022015 REV.1

ANIMO

